

**ISO 9001 : 2015 Certified Company**



# **NANOTE ENGINEERING AND INDUSTRIAL TRAINING PVT. LTD.**

IT'S TRAINING MATERIAL MANUFACTURER AND SUPPLIER COMPANY



**Channel Partner of**

**KAIZEN TECHNO SERVICES**



Nanote Engineering and Industrial Training Pvt. Ltd. is Carry on The Business of Manufacturing 6 Axis Training Kit, DOJO / Safety Training Kit, Material Handling Equipment, Special Inspection Table, Hot Air Seam Sealing Machine, Customised Fabrication Item & SPM of Industrial use.

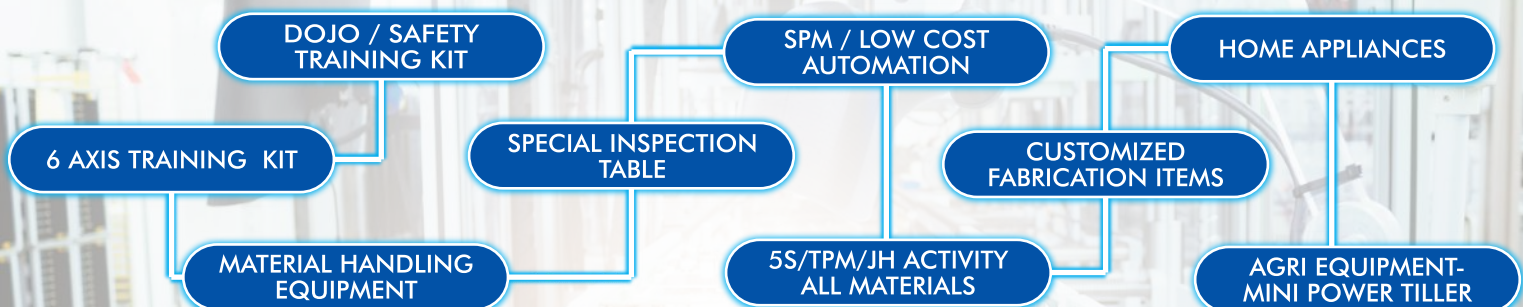

# 6 AXIS TRAINING KIT



**HYDRAULIC TRAINING KIT**

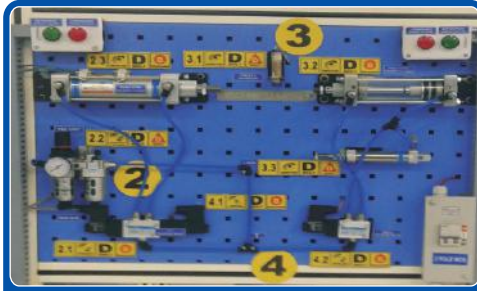

**PNEUMATIC TRAINING KIT**



**ELECTRICAL TRAINING KIT**



**PLC TRAINING KIT**



**DRIVES TRAINING KIT**

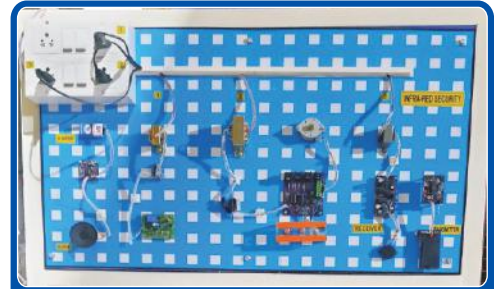

**ELECTRONIC TRAINING KIT**



**CENTRALISE OIL +AIR**



**CENTRALISE GREASE**



**CENTRALISE OIL**

# DOJO / SAFETY TRAINING KIT



**ELECTRICAL SAFETY DO JO KIT**



**REVOLVING MACHINE DO JO KIT**



**DOUBLE PUSH BUTTON DO JO KIT**



**ROTATING ROBOT DO JO KIT**



**HOT SURFACE DO JO KIT**



**SAFETY SHOES DO JO KIT**

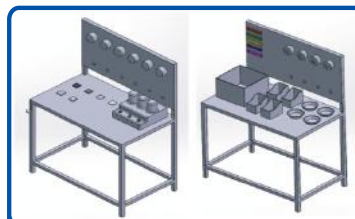

**5 SENCE KIT**



**TPM INFORMATION MODEL**

# MATERIAL HANDLING EQUIPMENT



**AEROPLANE WINGS RACK**



**BAR STORAGE RACK**



**MATERIAL STORAGE RACK**



**MATERIAL STORAGE RACK**



**MATERIAL STORAGE RACK**

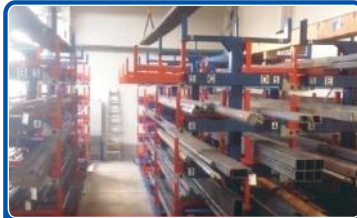

**MATERIAL STORAGE RACK**



**MATERIAL STORAGE TROLLEY**



**MATERIAL HANDLING LADDER**



**MATERIAL STORAGE TROLLEY**



**MATERIAL STORAGE TROLLEY**



**MATERIAL STORAGE TROLLEY**



**MATERIAL HANDLING TROLLEY**



**MATERIAL HANDLING TROLLEY**



**MATERIAL STORAGE TROLLEY**

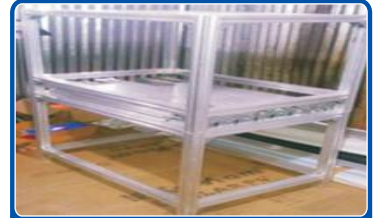

**MATERIAL STORAGE TROLLEY**

# INSPECTION TABLE



**MS INSPECTION TABLE**



**SS INSPECTION TABLE**



**MS INSPECTION TABLE**



**MS INSPECTION TABLE**



**ALL PROFILE INSPECTION TABLE**



**MS INSPECTION TABLE**



**MS INSPECTION TABLE**



**ASSEMBLY TABLE**

# SPECIAL TABLE



CANTEEN TABLE



CANTEEN TABLE



CANTEEN TABLE



CANTEEN TABLE

# SHADOW BOARDS - CUSTOMIZED ITEMS



# CLEANING EQUIPMENT STORAGE - CUSTOMIZED ITEMS



# CUT SECTION



**NANOTE**  
Engineering & Industrial  
Training Pvt. Ltd.



GEAR BOX



ELECTRIC MOTOR



GEAR BOX



DIRECTION CONTROL VALVE



TWO WHEELER ENGINE



TWO WHEELER ENGINE



DIRECTION CONTROL VALVE



GEAR BOX



FLOW CONTROL VALVE



CYLINDER

# SPM

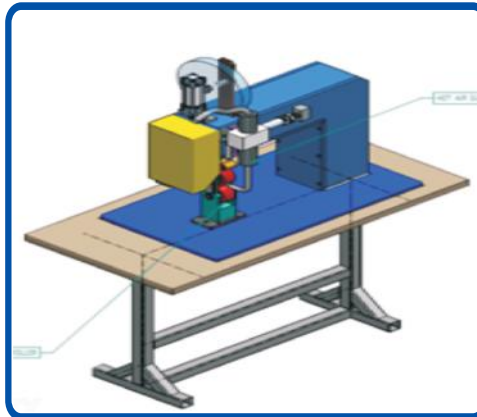

# TPM DISPLAY BOARD



**NANOTE**  
Engineering & Industrial  
Training Pvt. Ltd.



**JH ACTIVITY BOARD**



**DAILY QUALITY MEETING BOARD**



**SAFETY TRIANGLE BOARD**



**CUSTOMER COMPLAINT STATUS**



**OPERATING SYSTEM**

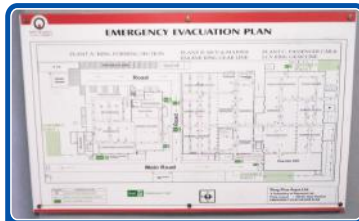

**EMERGENCY EVACUATION PLAN**

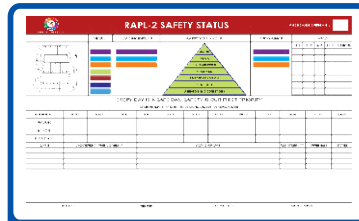

**SAFETY STATUS**



**TPM ACTIVITY BOARD**



**PQCDSM STATUS BOARD**



**DAILY PRODUCTION PLANNING**

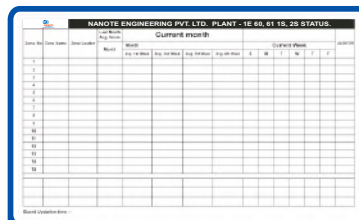

**5S STATUS**



**QUALITY SYSTEMS BASIS**

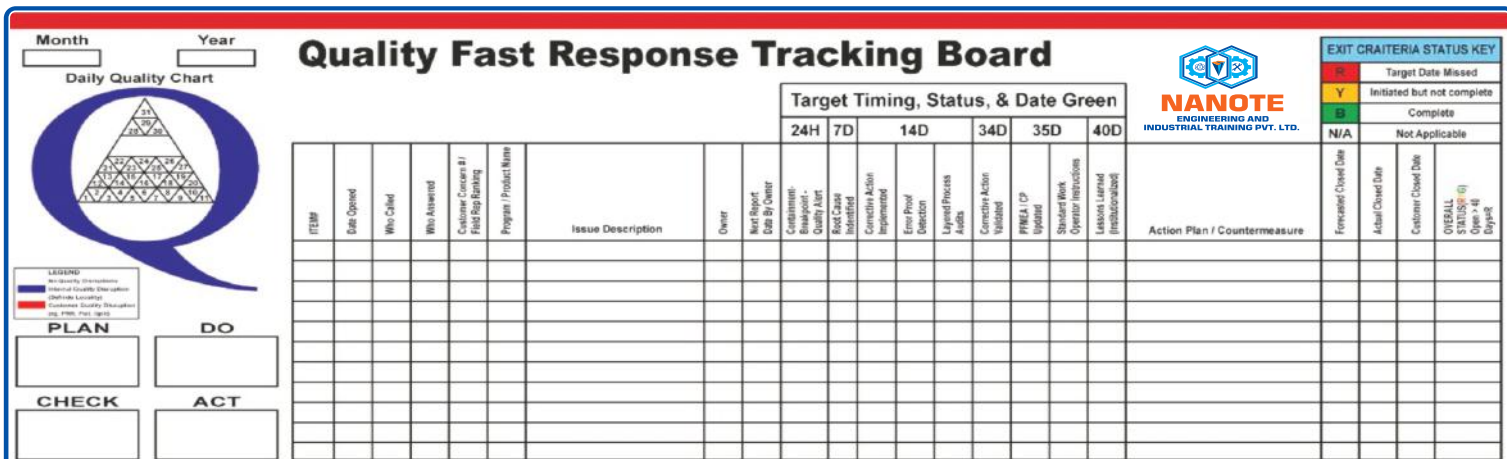

**QUALITY FAST RESPONSE TRACKING BOARD**

# HOMES APPLIANCES



# AGRICULTURAL EQUIPMENT-MINI POWER TILLER

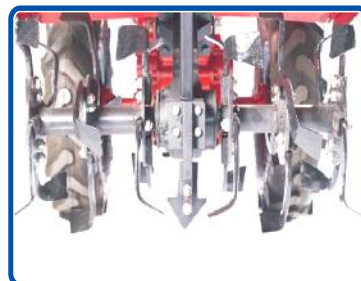

# OUR VALUED CUSTOMERS



**NANOTE**  
Engineering & Industrial  
Training Pvt. Ltd.

**KAIZEN TECHNO SERVICES**



Office Address : Flat No.4, S.No 27/, Aditya Nagar, Ashoka Marg, Nashik - 422011

Work Address : E-105, MIDC, Ambad, Nashik-422010, Maharashtra

Email : [kaizentechnonashik@gmail.com](mailto:kaizentechnonashik@gmail.com), [mktneitpv@gmail.com](mailto:mktneitpv@gmail.com) | Website : [www.nanoteengg.com](http://www.nanoteengg.com)

Contact Person : Mr. D.H.NANOTE -9922997991 (MD) | Mr. S.K.WAGH -9403376918 (MARKETING)